

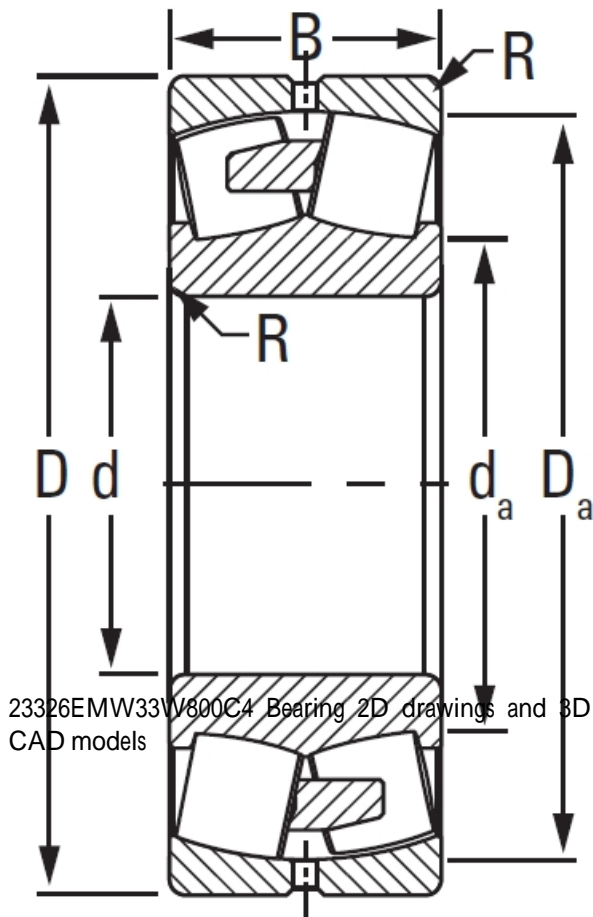

Precision Bearing Industry Co., Ltd.

TIMKEN 23326EMW33W800C4 Bearing

Bearing No. 23326EMW33W800C4



23326EMW33W800C4 Bearing 2D drawings and 3D CAD models

Design Unit	METRIC
Bearing Weight	33.8 Kg
Cage Type	EM
UPC Code	087796031937
Cage Material	Brass
Superseded Part	23326YMW33W800C4
d	130 mm
D	279.993 mm
B - Inner Ring Width	112 mm
B - Outer Ring Width	112.000 mm
R - Inner Ring To Clear Radius ¹	3.0 mm
r - Outer Ring To Clear Radius ²	3.0 mm
da - Inner Ring Backing Diameter	164.000 mm
Da - Outer Ring Backing Diameter	245.000 mm
C0 - Static Radial Rating	1590000 N
C1(2) - Dynamic Radial Rating (Two-Rows)	1340000 N
e - ISO Factor ³	0.42
Y0 - ISO Factor ⁴	1.62
Y1 - ISO Factor ⁵	2.42
Y2 - ISO Factor ⁶	1.59
Reference Thermal Speed Rating (Grease)	1200
Reference Thermal Speed	1400



Precision Bearing Industry Co., Ltd.

Rating (Oil) ⁷	
Cg - Geometry Factor ⁸	0.086