

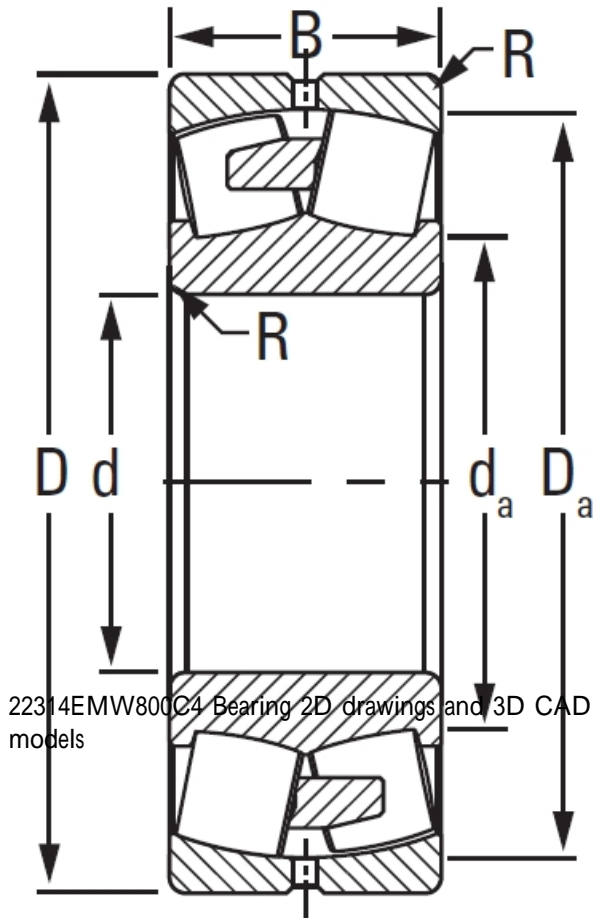

Precision Bearing Industry Co., Ltd.

TIMKEN 22314EMW800C4 Bearing

Bearing No. 22314EMW800C4



22314EMW800C4 Bearing 2D drawings and 3D CAD models

Design Unit	METRIC
Bearing Weight	4.4 Kg
Cage Type	EM
UPC Code	087796026384
Cage Material	Brass
Superseded Part	22314YMW800C4
d	70 mm
D	149.993 mm
B - Inner Ring Width	51 mm
B - Outer Ring Width	51.000 mm
R - Inner Ring To Clear Radius ¹	2.0 mm
r - Outer Ring To Clear Radius ²	2.0 mm
da - Inner Ring Backing Diameter	91.000 mm
Da - Outer Ring Backing Diameter	135.000 mm
C0 - Static Radial Rating	414000 N
C1(2) - Dynamic Radial Rating (Two-Rows)	395000 N
e - ISO Factor ³	0.33
Y0 - ISO Factor ⁴	2.07
Y1 - ISO Factor ⁵	3.08
Y2 - ISO Factor ⁶	2.02
Reference Thermal Speed Rating (Grease)	3600
Reference Thermal Speed	4200



Precision Bearing Industry Co., Ltd.

Rating (Oil) ⁷	
Cg - Geometry Factor ⁸	0.0589